

**Product Catalogue**

# **Ecodesign Transformers**

**We guarantee energy since 1979**



**Tesar**

A company of R&S



## Table of Contents

<b>5</b>	Our Brand Story
<b>6</b>	Energy
<b>8</b>	Reference Legislation, Norms and Standards
<b>9</b>	Our Proposal
<b>12</b>	Technical Details
<b>20</b>	A World of Reliability
<b>21</b>	Special Applications
<b>22</b>	Metal Enclosures
<b>24</b>	Our Accessories
<b>26</b>	Description and Features
<b>27</b>	The main Features
<b>28</b>	Certified Quality
<b>29</b>	Environmental, Climate and Fire-resistance Classes
<b>33</b>	Customer-care and after-sales Service Activities
<b>34</b>	Sustainability
<b>36</b>	Test Room

# Sustainability

## ECO DESIGN TRANSFORMERS FOR SUSTAINABLE ENERGY



# Our Brand Story

TESAR was established in 1979.

After taking the first steps within the Italian market, our company started operating in the European Community market. Already in 1988 Tesar started providing supplies for CERN.

In 1993 the company achieved a fundamental goal connected with corporate growth, by becoming a supplier for Electricity Supply and Power Distribution Authorities, such as Dewa Dubai and the Ministry of Electricity and Water of the state of Kuwait. Over these 40 years of activity, Tesar has been studying casting processes, fire behaviour of transformers under service conditions, thus achieving essential information for the installation of transformers everywhere, but most of all in case the machinery that is installed within residential buildings. Tesar has started to develop studies on the resin aging and behavior through the years.

Tesar is at the forefront of transformer research together with Enel Venezia (Venice regional electricity utility), regarding the transformers which shall then be installed in this unique lagoon city: our innovative solutions made it possible for transformers to function even in periods of "aqua grande" ("high tide"). These transformers performed perfectly, even during the recent meteorological disasters (floods) that occurred in the lagoon.

Tesar can boast several goals achieved in both quality and research levels, confirming its position as a leading company in the field of technical studies on transformer standards and regulation updates.

Tesar are proud to announce that Tesar transformers are now installed in every stadium, covering every match of the Qatar 2022 World Cup.

Tesar manufactures cast resin transformers for all possible applications, from our standard proven distribution transformers, to power transformers up to 20 MVA – 52 kV. Furthermore, our production also includes transformers for industrial applications regarding AC/DC and DC/AC conversion with 6 – 12 – 18 and 24 pulse, traction transformers for railway networks, underground and tramway and multi-winding transformers for renewable energy sources (solar energy, wind energy, biomass energy and recharging stations for electric vehicles).

Tesar transformers can be defined as "Environmentally Friendly" because they have been designed and built using the best quality materials available in the market, offering extremely low losses and highly efficient performance, which massively contributes to the reduction of electric energy consumption and to the reduction of CO2 emissions.

Tesar technical experts are active members of European and International Technical Committees, dealing with studies, publication and updating of the necessary Technical Norms/Standards for the construction and testing of transformers.

Our workshops are equipped with the best and most up-to-date machines available for the construction of our products. We are world-known thanks to our transformer Quality and Reliability features.

Tesar operates under ISO 9001 quality management system certification, it is an environmentally friendly company in line with ISO 14001 standards and performs all activities in compliance with ISO 45001 safety standards.

More than 100,000 Tesar transformers have already been successfully installed in the five continents of the World, from the Americas, to Asia, from Africa to Oceania and obviously Europe.

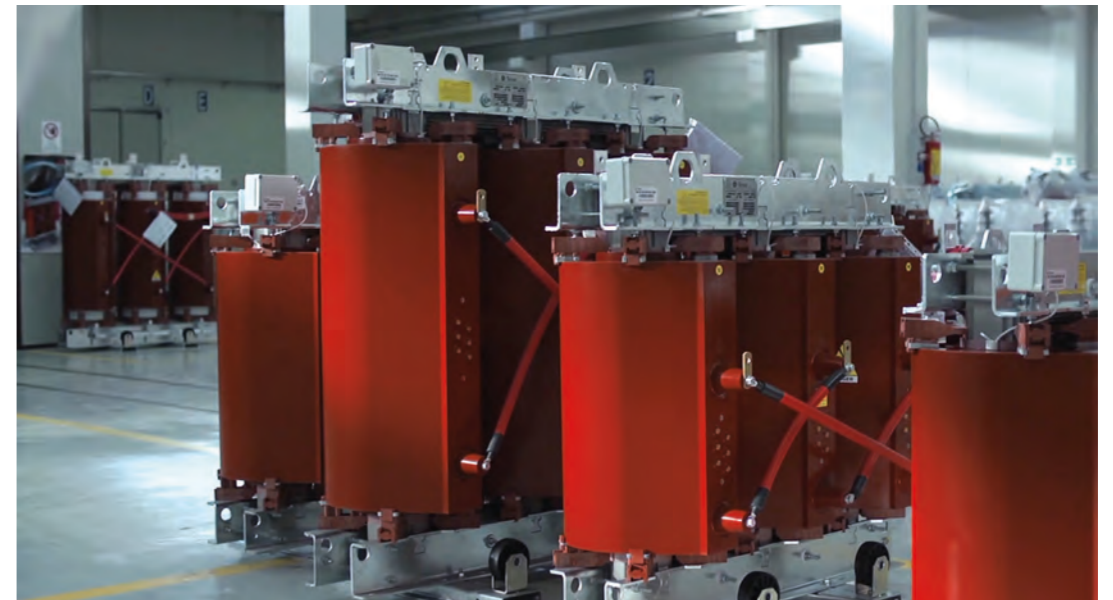

# Energy

## Tesar transformers, Wind, Sun and Water within the framework of Renewable Energies

After the Kyoto Protocol, the EU has been focusing on an ambitious target: the so-called 20-20-20 climate energy package. In 2021 the new target for 2030 consists of the reduction of greenhouse gas emissions by 40%, an increase of up to 32% of energy produced by means of renewable sources and finally, in the achievement of the target of a 32% energy saving: all these targets are to be achieved within 2030.

Within the field of transformers, the reduction of losses offers greater benefits for the environment, connected to a reduction in emissions of greenhouse gases.

Based on this simple hypothesis, the European Commission published the new 548/2014 directive, imposing Ecodesign Transformers, a directive which all European producers have

to comply with.

The new directive has been applied in two phases, the first one starting from July 2015 and the second one from July 2021. According to a study of the European Commission, it is estimated that over 2.5% of the overall energy consumed by EU countries is wasted through transformers' losses.

The ambitious goal is to reduce yearly overall losses of all installed transformers by 3.7 tons gas emissions each year, within 2025. As a consequence Tesar aims at always supplying sustainable transformers in order to fully comply with Ecodesign norms. From an economic point of view, it is important to keep into account the fact that the standard definition of the cost of the product life-cycle, corresponds to the sum of its purchase price plus the costs to be faced during its life cycle.

As a consequence a transformer with reduced losses features a higher purchase price, whereas transformers planned with a minimum production cost shall imply higher losses and extraordinary operating expenses.

Taking into account the fact that transformers are powered 24 hours a day, 365 days a year and that they have a very long life-cycle, usually 30 years, energy consumption is a dominant factor.

This means that higher purchase costs are refunded by means of savings during the whole product life-cycle, since the purchase price is only a marginal part of the total cost of the machine, whereas operating expenses (mainly connected with losses) represent more than 80% of the total cost.

Taking into account a 1000kVA powered transformer, when comparing an Ecodesign transformer with a traditional one used within Extra-EU countries, the higher purchase price of the first one, can be recovered within two years only! Costs savings in 30 years are equal to about 45,000 Euro with substantial advantages also as regards the environmental impact, with a reduction of greenhouse emissions of about 5 tons a year!



	Extra-EU design	Ecodesign
Nominal power (kVA)	1000	1000
Idle/no-load running losses (W)	2300	1395
Under load losses @ 120°C (W)	10800	9000
Purchase prices (€)	10500	13500
Idle running (idle running losses)		
Hours/ Day	24	24
Days / Year	365	365
Under load running (under load losses)		
Hours/ Day	8	8
Days / Year	220	220
Power factor	80%	80%
Energy average cost (€ / kWh)	0.175	0.175
Yearly cost for losses (€ / year)	5.655	4.150

Yearly energy saving (kWh / year)	8.598
Yearly saving regarding operational expenses (€ / year)	1.505
Average lifecycle of transformers (years)	30
Saving in operational expenses in 30 years (€)	45.137
Refund (years)	2
Average CO2 emission factor (gCO2/kWh)	540
CO2 emission saving in a year (t/year)	5

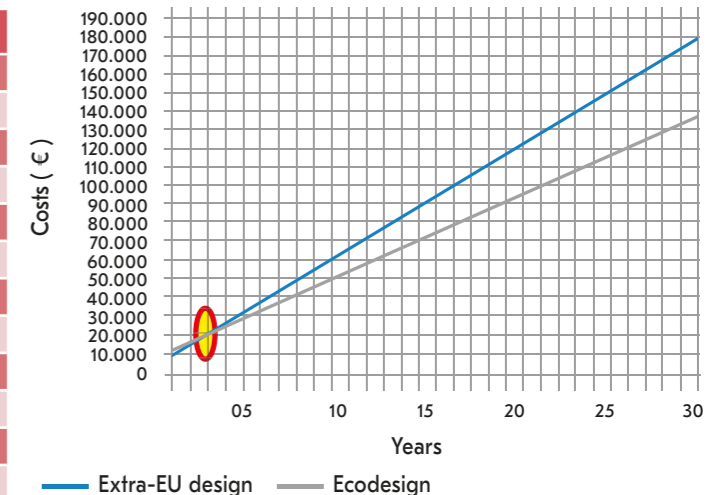

Ecodesign Transformer compared with Extra-EU design

# Reference Legislation, Norms and Standards

## State of the Art

### Tesar transformers exceed average performance standards

Over the years several norms have brought an increase in the efficiency level of cast resin transformers, starting with HD 538; in 2004 IEC 60076-11 international directives were published: they represent the first real guideline in the field of dry-type transformers and they include, amongst other things, the milestone regarding climate, environmental, and fire-behaviour classes (E-C-F). In September the 2015 EN 50588-1 directive, replacing all previous revisions up to 2018, was published. The above-mentioned norm implements UE 548/2014 standard dated 21<sup>st</sup> May 2014, establishing new minimum efficiency requirements for transformers, in case they were installed after 1<sup>st</sup> July 2015.

As from July 2019 the new IEC 60076-11:2018-10 standard comes into force and is to be applied to both oil-cooled transformers and cast resin transformers.

Apart from IEC directives for all transformers installed within the European Community, one has to also refer to the EU548/2014 directive, which establishes the maximum value for idle-running losses and losses under load for transformers with nominal power up to 3150kVA. As regards higher powers, this directive introduces the Peak Efficiency Index (PEI) so as to choose the best combination of losses based upon the type of use of the transformer.

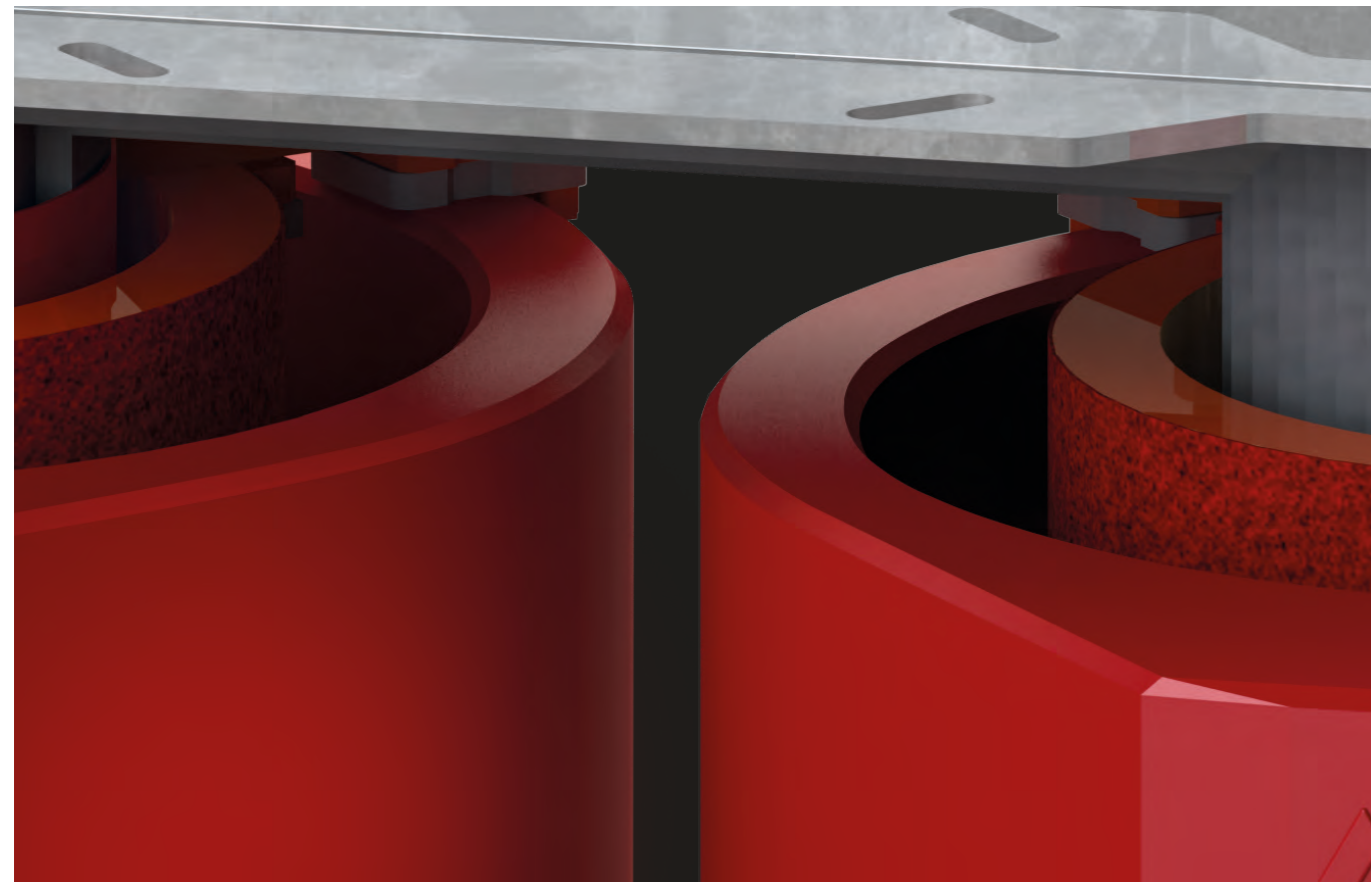

# Our Proposal

## Italian Quality

### Tesar transformers can meet different requirements and needs

#### Ecodesign Transformers

This kind of transformer complies with EU Ecodesign Directive (EU548/2014) and with the IEC 60076-11:2018-10 standard. It makes it possible to reduce energy consumption and, as a consequence, to reduce greenhouse emissions. This is our Top-of-the-line Model.

#### Extra-EU design Transformer

The strength of this transformer, featuring a maximum nominal power of 3150kVA, lies in its lightweight characteristics, if compared with an Ecodesign model with equal characteristics. Thanks to this feature, it represents the best compromise in case of restrictions or, limits as regards weight or, dimensions.

#### Transformers for railway rectifiers

It features from 6 up to 24 impulses, it has been planned for overloads and it is suitable for installation in railways, undergrounds, tramways and other applications connected with electro-mobility. It is qualified for use with RFI (Italian Railway Network) and other main institutions within the railway sector.

#### Transformers for rectifiers

From 6, 12, 18 and 24 pulse up to 20MVA; it is suitable for any industrial application within this field.

#### Transformers for power generation facilities

Within the power generation sector we manufacture transformers which can be installed in any kind of (photovoltaic, wind, hydroelectric, etc.) power plant.

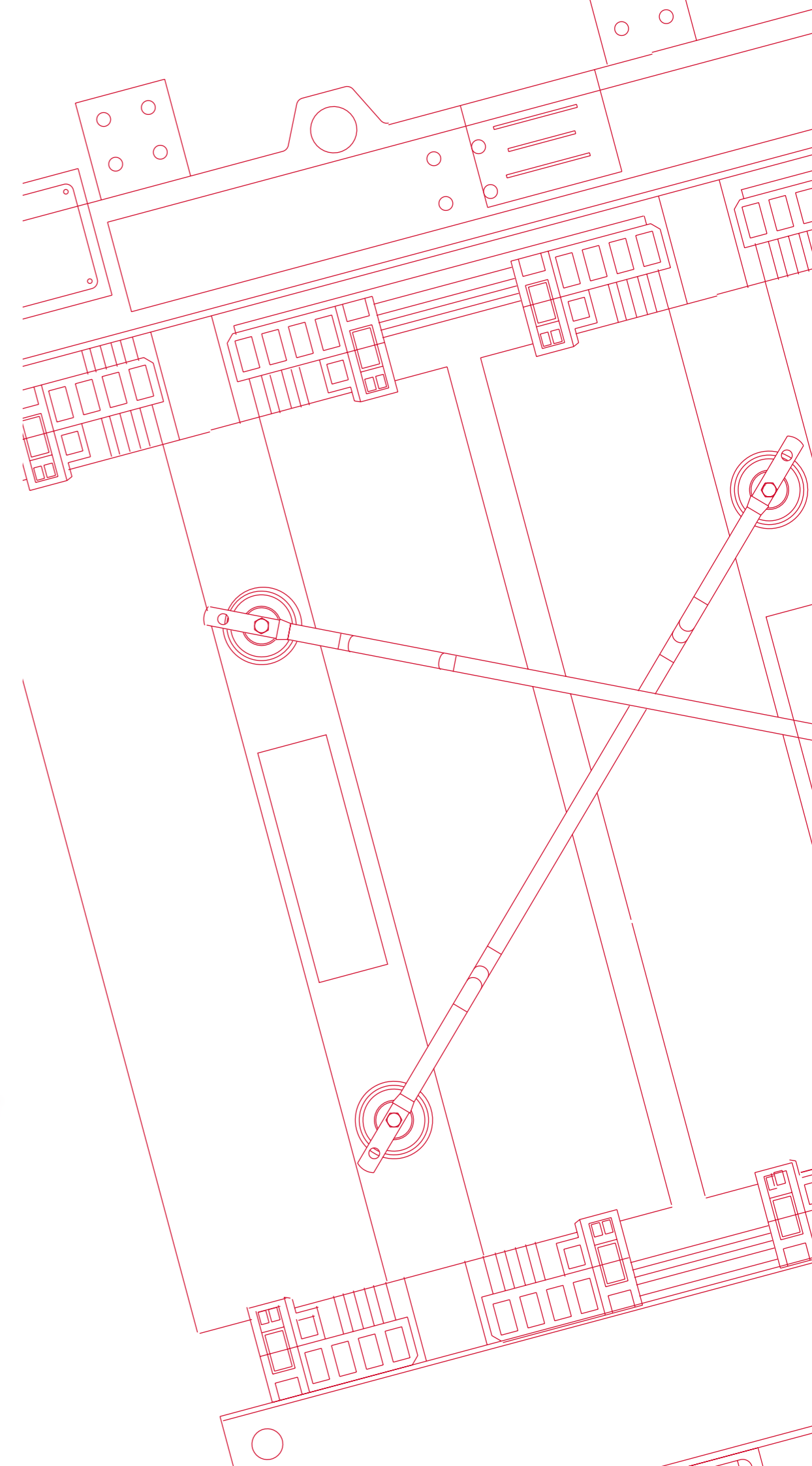

# Technical Details

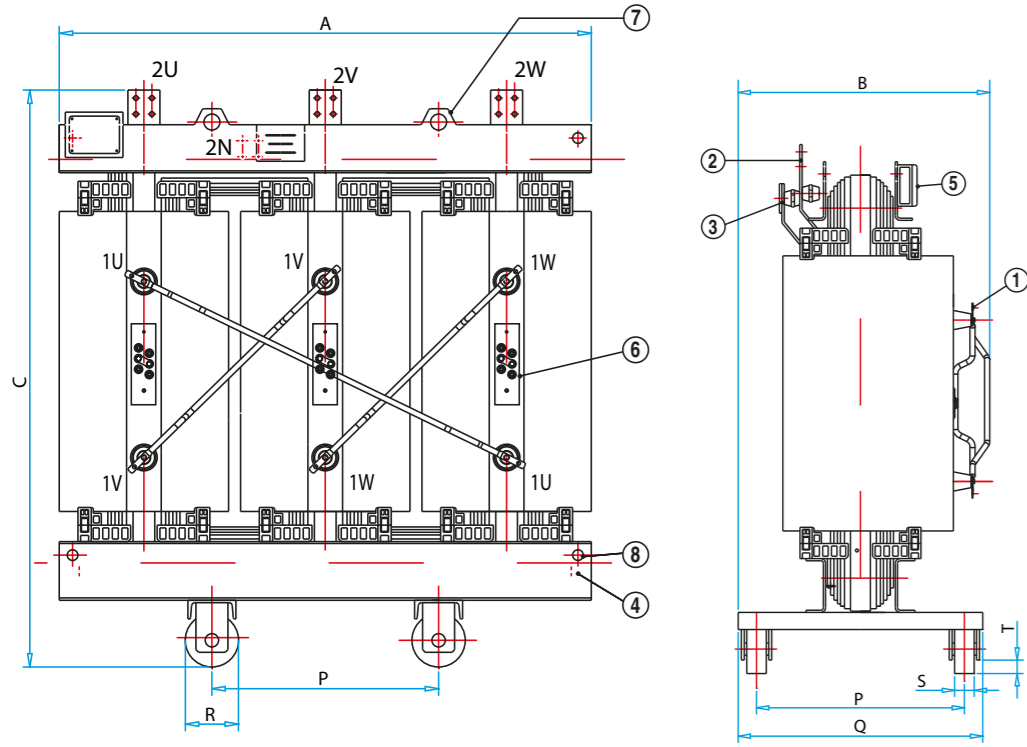

- 1 HV Terminal
- 2 LV Terminal
- 3 Neutral Terminal
- 4 Ground Terminal
- 5 Junction box
- 6 Terminal board
- 7 Lifting eye bolts
- 8 Towing hooks

PT 100 ohm Connections Diagram

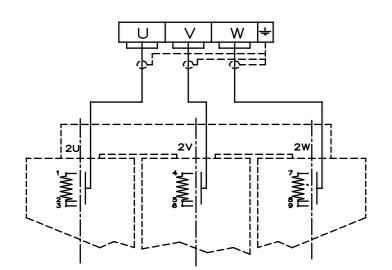

Terminal Board

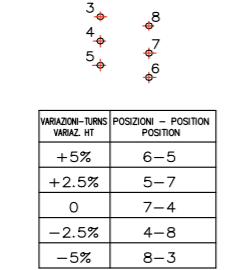

LV Terminal

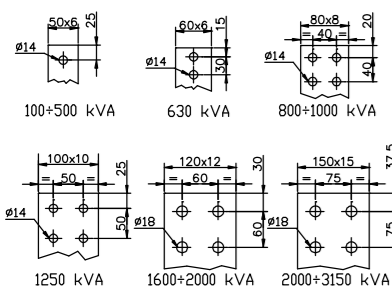

HV Terminal

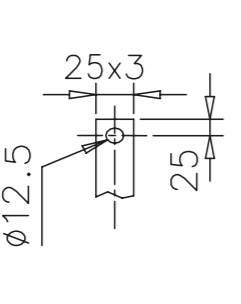

# Technical Details EU548/2014

Norm	IEC 60076
Installation	Indoor
Height	< 1000 m
Type of cooling system	AN
Winding Material	AL / AL
Ambient / room Temperature	40° C
Overtemperature	100 / 100 K

Primary Voltage	up to 12 kV
Insulation	12/28/75 kV
Adjustment	+/- 2x2.5%
Secondary Voltage	400 V
Vector Group	Dyn11-Dyn5
Frequency	50 Hz
Insulation Class	F / F
Degree of protection	IP00

# 12kV

Nominal Power	Series	Po	Pcc 120°C	Vcc 120°C	Io	Performance		Voltage drop/dip		LpA	LwA	A	B	C	P	Q	R	S	T	Mass	Enclosure Model
						cosφ 1 100% load	cosφ 1 75% load	cosφ 1 100% load	cosφ 0,9 100% load												
100	Extra-EU design	440	1955	4	2.3	97.66	97.99	2.02	3.31	48	61	1100	680	1190	520	620	125	40	35	550	Box 1/...
	Ecodesign phase 2	252	1800	6	2.3	97.99	98.34	1.96	4.21	39	51	1150	710	1250	520	620	125	40	35	900	Box 1/...
160	Extra-EU design	610	2650	4	2.0	98.00	98.28	1.74	3.28	54	67	1100	690	1240	520	620	125	40	35	800	Box 1/...
	Ecodesign phase 2	360	2600	6	2.0	98.18	98.50	1.79	4.08	42	54	1190	750	1240	520	620	125	40	35	950	Box 1/...
250	Extra-EU design	820	3450	4	1.8	98.32	98.55	1.46	3.03	54	67	1240	725	1265	520	620	125	40	35	1050	Box 1/...
	Ecodesign phase 2	468	3400	6	1.8	98.48	98.75	1.53	3.88	45	57	1240	750	1450	520	620	125	40	35	1250	Box 1z/...
315	Extra-EU design	1000	4400	4	1.7	98.31	98.55	1.48	3.05	56	70	1240	735	1360	520	620	125	40	35	1170	Box 1/...
	Ecodesign phase 2	555	3875	6	1.7	98.61	98.86	1.40	3.78	46	59	1290	750	1500	520	770	125	40	35	1400	Box 2/...
400	Extra-EU design	1150	4950	4	1.5	98.50	98.71	1.32	2.90	57	71	1240	795	1505	670	770	125	40	35	1300	Box 1/...
	Ecodesign phase 2	675	4500	6	1.5	98.72	98.94	1.30	3.70	47	60	1360	840	1540	670	770	125	40	35	1650	Box 2/...
500	Extra-EU design	1400	6200	4	1.4	98.50	98.71	1.32	2.91	57	71	1290	810	1495	670	770	125	40	35	1500	Box 1/...
	Ecodesign phase 2	811	5630	6	1.4	98.73	98.95	1.30	3.70	48	61	1410	840	1730	670	770	125	40	35	1850	Box 2z/...
630	Extra-EU design	1500	7350	4	1.3	98.61	98.82	1.25	2.84	58	72	1290	810	1710	670	770	125	40	35	1750	Box 2/...
	Ecodesign phase 2	990	7100	6	1.3	98.73	98.96	1.30	3.70	49	62	1420	830	1720	670	770	125	40	35	1950	Box 2z/...
800	Extra-EU design	1800	9400	6	1.1	98.62	98.83	1.35	3.79	59	73	1430	835	1775	670	770	125	40	35	1950	Box 2/...
	Ecodesign phase 2	1170	8000	6	1.1	98.87	99.06	1.18	3.60	50	64	1450	860	1860	670	770	125	40	35	2500	Box 3/...
1000	Extra-EU design	2000	10100	6	1.0	98.80	98.99	1.19	3.65	60	74	1500	1000	1875	820	1000	125	40	35	2300	Box 2/...
	Ecodesign phase 2	1395	9000	6	1.0	98.97	99.15	1.08	3.52	51	65	1540	1000	1930	820	1000	125	40	35	2800	Box 3/...
1250	Extra-EU design	2400	12650	6	0.9	98.81	99.00	1.19	3.65	62	76	1500	1000	1975	820	1000	125	40	35	2600	Box 2/...
	Ecodesign phase 2	1620	11000	6	0.9	99.00	99.17	1.06	3.50	53	67	1570	1000	2100	820	1000	125	40	35	3400	Box 3z/...
1600	Extra-EU design	2800	14600	6	0.9	98.92	99.09	1.09	3.56	62	76	1680	970	2215	820	1000	200	70	50	3300	Box 3/...
	Ecodesign phase 2	1980	13000	6	0.9	99.07	99.23	0.99	3.45	54	68	1770	1000	2180	820	1000	200	70	50	4000	Box 3z/...
2000	Extra-EU design	3800	18000	6	0.8	98.92	99.08	1.08	3.55	63	78	1770	1095	2370	1070	1200	200	70	50	4150	Box 3/...
	Ecodesign phase 2	2340	16000	6	0.8	99.09	99.25	0.98	3.44	55	70	1880	1200	2320	1070	1200	200	70	50	4750	Box 3z/...
2500	Extra-EU design	4300	21800	6	0.7	98.97	99.12	1.05	3.53	65	80	1940	1140	2425	1070	1200	200	70	50	4900	Box 3/...
	Ecodesign phase 2	2790	19000	6	0.7	99.14	99.29	0.94	3.40	56	71	1970	1200	2420	1070	1200	200	70	50	5850	Box 4z/...
3150	Extra-EU design	5500	24150	8	0.6	99.07	99.20	1.08	4.39	66	81	2100	1145	2430	1070	1200	200	70	50	5900	Box 4/...
	Ecodesign phase 2	3420	22000	8	0.6	99.20	99.34	1.02	4.34	58	74	2320	1200	2480	1070	1200	200	70	50	7350	Box 4z/...

Different Designs (i.e. Ambient / room Temperature, B or H insulation class and different conductive material, etc.) are available on demand  
Our company reserves the right to modify technical details without prior notice

# Technical Details

## EU548/2014

Norm	IEC 60076
Installation	Indoor
Height	< 1000 m
Type of cooling	AN
Winding Material	AL / AL
Ambient/room Temperature	40° C
Overtemperature	100 / 100 K

Primary voltage	up to 17.5 kV
Insulation	17/38/95 kV
Adjustment	+/- 2x2.5%
Secondary voltage	400 V
Vector Group	Dyn11-Dyn5
Frequency	50 Hz
Insulation Class	F / F
Degree of protection	IP00

# 17,5kV

Nominal Power	Series	Po	Pcc 120°C	Vcc 120°C	Io	Performance		Voltage dip		LpA	LwA	A	B	C	P	Q	R	S	T	Mass	Enclosure Model	
						cosφ 1 100% load	cosφ 1 75% load	cosφ 1 100% load	cosφ 0,9 100% load													
kVA		W	W	%	%	%	%	%	%	dB	dB	mm	mm	mm	mm	mm	mm	mm	mm	mm	kg	
100	Extra-EU design	480	2050	6	2.3	97.53	97.87	2.21	4.39	48	61	1200	690	1240	520	620	125	40	35	550	Box 1/...	
	Ecodesign phase 2	252	1800	6	2.3	97.99	98.34	1.96	4.21	39	51	1220	760	1240	520	620	125	40	35	900	Box 2/...	
160	Extra-EU design	650	2760	6	2.0	97.91	98.20	1.90	4.28	54	67	1240	720	1190	520	620	125	40	35	780	Box 1/...	
	Ecodesign phase 2	360	2600	6	2.0	98.18	98.50	1.79	4.08	42	54	1240	780	1310	520	620	125	40	35	1000	Box 2/...	
250	Extra-EU design	880	3800	6	1.8	98.16	98.42	1.70	4.10	54	67	1240	745	1210	520	620	125	40	35	1000	Box 1/...	
	Ecodesign phase 2	468	3400	6	1.8	98.48	98.75	1.53	3.88	45	57	1320	780	1520	520	620	125	40	35	1500	Box 2/...	
315	Extra-EU design	1030	4600	6	1.7	98.24	98.49	1.64	4.04	56	70	1240	735	1455	520	620	125	40	35	1100	Box 1/...	
	Ecodesign phase 2	555	3875	6	1.7	98.61	98.86	1.40	3.78	46	59	1410	820	1550	520	770	125	40	35	1550	Box 2/...	
400	Extra-EU design	1250	5500	6	1.5	98.34	98.57	1.55	3.97	57	71	1290	810	1475	670	770	125	40	35	1280	Box 1/...	
	Ecodesign phase 2	675	4500	6	1.5	98.72	98.94	1.30	3.70	47	60	1410	880	1650	670	770	125	40	35	1700	Box 2/...	
500	Extra-EU design	1400	6780	6	1.4	98.39	98.63	1.54	3.95	57	71	1290	810	1600	670	770	125	40	35	1450	Box 1/...	
	Ecodesign phase 2	811	5630	6	1.4	98.73	98.95	1.30	3.70	48	61	1410	840	1780	670	770	125	40	35	1800	Box 2z/...	
630	Extra-EU design	1650	7800	6	1.3	98.52	98.74	1.42	3.85	58	72	1290	825	1710	670	770	125	40	35	1650	Box 2/...	
	Ecodesign phase 2	990	7100	6	1.3	98.73	98.96	1.30	3.70	49	62	1500	860	1810	670	770	125	40	35	2200	Box 2z/...	
800	Extra-EU design	2000	9200	6	1.1	98.62	98.82	1.33	3.77	59	73	1430	835	1775	670	770	125	40	35	1960	Box 3/...	
	Ecodesign phase 2	1170	8000	6	1.1	98.87	99.06	1.18	3.60	50	64	1500	900	1890	670	770	125	40	35	2500	Box 3/...	
1000	Extra-EU design	2400	10800	6	1.0	98.70	98.88	1.26	3.71	60	74	1500	1000	1875	820	1000	125	40	35	2100	Box 2/...	
	Ecodesign phase 2	1395	9000	6	1.0	98.97	99.15	1.08	3.52	51	65	1600	1020	1960	820	1000	125	40	35	3050	Box 3/...	
1250	Extra-EU design	2800	13100	6	0.9	98.74	98.93	1.23	3.68	62	76	1500	1000	1975	820	1000	125	40	35	2650	Box 3/...	
	Ecodesign phase 2	1620	11000	6	0.9	99.00	99.17	1.06	3.50	53	67	1660	1000	2120	820	1000	125	40	35	3550	Box 3z/...	
1600	Extra-EU design	3500	15520	6	0.9	98.83	98.99	1.15	3.61	62	76	1680	970	2215	820	1000	200	70	50	3350	Box 4/...	
	Ecodesign phase 2	1980	13000	6	0.9	99.07	99.23	0.99	3.45	54	68	1790	1030	2380	820	1000	200	70	50	4350	Box 4z/...	
2000	Extra-EU design	4400	18400	6	0.8	98.87	99.03	1.10	3.57	63	78	1770	1095	2370	1070	1200	200	70	50	4180	Box 4/...	
	Ecodesign phase 2	2340	16000	6	0.8	99.09	99.25	0.98	3.44	55	70	1900	1200	2440	1070	1200	200	70	50	5550	Box 4z/...	
2500	Extra-EU design	5000	21800	6	0.7	98.94	99.09	1.05	3.53	65	80	1940	1140	2415	1070	1200	200	70	50	4900	Box 4z/...	
	Ecodesign phase 2	2790	19000	6	0.7	99.14	99.29	0.94	3.40	56	71	2020	1200	2470	1070	1200	200	70	50	6050	Box 4z/...	
3150	Extra-EU design	6000	23575	8	0.6	99.07	99.19	1.07	4.38	66	81	2100	1155	2430	1070	1200	200	70	50	6600	Box 4z/...	
	Ecodesign phase 2	3420	22000	8	0.6	99.20	99.34	1.02	4.34	58	74	2270	1210	2520	1070	1200	200	70	50	7350	Box xx/...	

Different Designs (i.e. Ambient / room Temperature, B or H insulation class and different conductive material, etc.) are available on demand

Our company reserves the right to modify technical details without prior notice

# Technical Details

## EU548/2014

Norm	IEC 60076
Installation	Indoor
Height	< 1000 m
Type of cooling system	AN
Winding Material	AL / AL
Ambient/room Temperature	40° C
Overtemperature	100 / 100 K

Primary voltage	Up to 24 kV
Insulation	24/50/125 kV
Adjustment	+/- 2x2.5%
Secondary voltage	400 V
Vector Group	Dyn11-Dyn5
Frequency	50 Hz
Insulation Class	F / F
Degree of protection	IP00

# 24kV

Nominal Power	Series	Po	Pcc 120°C	Vcc 120°C	Io	Performance		Voltage dip		LpA	LwA	A	B	C	P	Q	R	S	T	Mass	Enclosure Model	
						cosφ 1 100% load	cosφ 1 75% load	cosφ 1 100% load	cosφ 0.9 100% load													
kVA		W	W	%	%	%	%	%	%	dB	dB	mm	mm	mm	mm	mm	mm	mm	mm	mm	kg	
100	Extra-EU design	480	1955	6	2.3	97.62	97.94	2.13	4.48	48	61	1200	760	1240	520	620	125	40	35	580	Box 1/...	
	Ecodesign phase 2	252	1800	6	2.3	97.99	98.34	1.96	4.21	39	51	1220	760	1240	520	620	125	40	35	900	Box 2/...	
160	Extra-EU design	650	2850	6	2.0	97.86	98.16	1.96	4.33	54	67	1240	750	1250	520	620	125	40	35	800	Box 1/...	
	Ecodesign phase 2	360	2600	6	2.0	98.18	98.50	1.79	4.08	42	54	1240	780	1310	520	620	125	40	35	1000	Box 2/...	
250	Extra-EU design	880	3800	6	1.8	98.16	98.42	1.70	4.10	54	67	1290	775	1410	520	620	125	40	35	1050	Box 1/...	
	Ecodesign phase 2	468	3400	6	1.8	98.48	98.75	1.53	3.88	45	57	1320	780	1500	520	620	125	40	35	1350	Box 2/...	
315	Extra-EU design	1030	4600	6	1.7	98.24	98.49	1.64	4.04	56	70	1290	770	1525	520	620	125	40	35	1200	Box 1/...	
	Ecodesign phase 2	555	3875	6	1.7	98.61	98.86	1.40	3.78	46	59	1410	820	1550	520	770	125	40	35	1550	Box 2/...	
400	Extra-EU design	1200	5500	6	1.5	98.35	98.59	1.55	3.97	57	71	1320	845	1565	670	770	125	40	35	1300	Box 1/...	
	Ecodesign phase 2	675	4500	6	1.5	98.72	98.94	1.30	3.70	47	60	1410	880	1650	670	770	125	40	35	1700	Box 2/...	
500	Extra-EU design	1400	6780	6	1.4	98.39	98.63	1.54	3.95	57	71	1430	850	1620	670	770	125	40	35	1550	Box 1/...	
	Ecodesign phase 2	811	5630	6	1.4	98.73	98.95	1.30	3.70	48	61	1410	880	1780	670	770	125	40	35	1800	Box 2z/...	
630	Extra-EU design	1650	7800	6	1.3	98.52	98.74	1.42	3.85	58	72	1430	885	1760	670	770	125	40	35	1800	Box 2/...	
	Ecodesign phase 2	990	7100	6	1.3	98.73	98.96	1.30	3.70	49	62	1500	890	1810	670	770	125	40	35	2200	Box 3/...	
800	Extra-EU design	2000	9200	6	1.1	98.62	98.82	1.33	3.77	59	73	1500	890	1810	670	770	125	40	35	2150	Box 3/...	
	Ecodesign phase 2	1170	8000	6	1.1	98.87	99.06	1.18	3.60	50	64	1500	900	1890	670	770	125	40	35	2500	Box 3/...	
1000	Extra-EU design	2300	10800	6	1.0	98.71	98.90	1.26	3.71	60	74	1500	1000	1960	820	1000	125	40	35	2500	Box 2/...	
	Ecodesign phase 2	1395	9000	6	1.0	98.97	99.15	1.08	3.52	51	65	1570	1010	1950	820	1000	125	40	35	2850	Box 3/...	
1250	Extra-EU design	2700	13100	6	0.9	98.75	98.94	1.23	3.68	62	76	1600	1000	1975	820	1000	125	40	35	2850	Box 3/...	
	Ecodesign phase 2	1620	11000	6	0.9	99.00	99.17	1.06	3.50	53	67	1660	1000	2130	820	1000	125	40	35	3550	Box 3z/...	
1600	Extra-EU design	3100	15800	6	0.9	98.83	99.01	1.17	3.63	62	76	1680	1025	2265	820	1000	200	70	50	3450	Box 4/...	
	Ecodesign phase 2	1980	13000	6	0.9	99.07	99.23	0.99	3.45	54	68	1730	1010	2360	820	1000	200	70	50	4100	Box 4z/...	
2000	Extra-EU design	4000	18000	6	0.8	98.91	99.07	1.08	3.55	63	78	1830	1140	2420	1070	1200	200	70	50	4250	Box 4/...	
	Ecodesign phase 2	2340	16000	6	0.8	99.09	99.25	0.98	3.44	55	70	1900	1200	2440	1070	1200	200	70	50	5550	Box 4z/...	
2500	Extra-EU design	5000	21850	6	0.7	98.94	99.09	1.05	3.53	65	80	1940	1170	2470	1070	1200	200	70	50	5000	Box 4z/...	
	Ecodesign phase 2	2790	19000	6	0.7	99.14	99.29	0.94	3.40	56	71	2020	1220	2470	1070	1200	200	70	50	6050	Box 4z/...	
3150	Extra-EU design	5600	24150	8	0.6	99.06	99.19	1.09	4.41	66	81	2160	1200	2510	1070	1200	200	70	50	6300	Box 4z/...	
	Ecodesign phase 2	3420	22000	8	0.6	99.20	99.34	1.02	4.34	58	74	2270	1240	2520	1070	1200	200	70	50	7350	Box xx/...	

Different Designs (i.e. Ambient / room Temperature, B or H insulation class and different conductive material, etc.) are available on demand

Our company reserves the right to modify technical details without prior notice



# Technical Details

## EU548/2014

# 36kV

Norm	IEC 60076
Installation	Indoor
Height	< 1000 m
Type of cooling system	AN
Winding Material	AL / AL
Ambient Temperature	40° C
Overtemperature	100 / 100 K

Primary voltage	Up to 36 kV
Insulation	36/70/170 kV
Adjustment	+/- 2x2.5%
Secondary voltage	400 V
Vector Group	Dyn11-Dyn5
Frequency	50 Hz
Insulation Class	F / F
Degree of protection	IP00

Nominal Power	Series	Po	Pcc 120°C	Vcc 120°C	Io	Performance		Voltage dip		LpA	LwA	A	B	C	P	Q	R	S	T	Mass	Enclosure Model	
						cosφ 1 100% load	cosφ 1 75% load	cosφ 1 100% load	cosφ 0,9 100% load													
kVA		W	W	%	%	%	%	%	%	dB	dB	mm	mm	mm	mm	mm	mm	mm	mm	mm	kg	
100	Extra-EU design	700	2312	6	2.0	97.36	97.66	2.25	4.42	51	64	1500	800	1550	520	620	125	40	35	1200	Box 2/...	
	Ecodesign phase 2	289	1980	6	2.0	97.99	98.34	1.95	4.20	42	54	1480	845	1840	520	620	125	40	35	1550	Box 2/...	
160	Extra-EU design	1000	3340	6	2.0	97.36	97.66	2.25	4.42	51	64	1500	800	1550	520	620	125	40	35	1200	Box 2/...	
	Ecodesign phase 2	414	2860	6	2.0	97.99	98.34	1.95	4.20	42	54	1550	900	1900	520	620	125	40	35	1850	Box 2/...	
250	Extra-EU design	1300	4600	6	1.8	97.69	97.97	2.00	4.24	54	67	1550	850	1600	520	620	125	40	35	1350	Box 2/...	
	Ecodesign phase 2	538	3740	6	1.8	98.32	98.61	1.66	3.98	45	57	1600	920	1950	670	620	125	40	35	2250	Box 2/...	
315	Extra-EU design	1500	5290	6	1.7	97.89	98.14	1.85	4.12	56	70	1600	850	1700	520	770	125	40	35	1600	Box 2/...	
	Ecodesign phase 2	638	4262	6	1.7	98.47	98.73	1.52	3.87	46	59	1650	935	2000	520	770	125	40	35	2500	Box 2z/...	
400	Extra-EU design	1650	5750	6	1.5	98.18	98.40	1.61	3.94	57	71	1650	900	1820	670	770	125	40	35	1900	Box 2/...	
	Ecodesign phase 2	776	4950	6	1.5	98.59	98.83	1.41	3.79	47	60	1700	950	2050	670	770	125	40	35	2850	Box 2z/...	
500	Extra-EU design	1950	6900	6	1.4	98.26	98.47	1.55	3.90	57	71	1700	900	1850	670	770	125	40	35	2100	Box 3/...	
	Ecodesign phase 2	933	6193	6	1.4	98.59	98.84	1.41	3.79	48	61	1750	970	2100	670	770	125	40	35	3750	Box 3z/...	
630	Extra-EU design	2200	8050	6	1.3	98.40	98.60	1.45	3.82	58	72	1730	950	2000	670	770	125	40	35	2450	Box 4/...	
	Ecodesign phase 2	1138	7810	6	1.3	98.60	98.84	1.41	3.79	49	62	1800	1000	2150	670	770	125	40	35	3750	Box 4z/...	
800	Extra-EU design	2700	9430	6	1.1	98.51	98.68	1.35	3.74	59	73	1750	1000	2100	670	770	125	40	35	2850	Box 4z/...	
	Ecodesign phase 2	1345	8800	6	1.1	98.75	98.96	1.27	3.68	50	64	1850	1050	2300	670	770	125	40	35	4000	Box xx/...	
1000	Extra-EU design	3300	10500	7	1.0	98.64	98.79	1.29	4.13	60	74	1800	1100	2350	820	1000	125	40	35	3200	Box xx/...	
	Ecodesign phase 2	1604	9900	7	1.0	98.86	99.05	1.23	4.08	51	65	1850	1100	2500	820	1000	125	40	35	4250	Box xx/...	
1250	Extra-EU design	3700	14950	8	0.9	98.53	98.72	1.51	4.74	62	76	1850	1100	2400	820	1000	125	40	35	3400	Box xx/...	
	Ecodesign phase 2	1863	12100	8	0.9	98.90	99.08	1.28	4.56	53	67	1950	1150	2550	820	1000	125	40	35	4850	Box xx/...	
1600	Extra-EU design	4200	17250	8	0.9	98.68	98.85	1.39	4.65	62	76	2000	1100	2450	820	1000	125	40	35	4450	Box xx/...	
	Ecodesign phase 2	2277	14300	8	0.9	98.97	99.15	1.21	4.50	54	68	2100	1200	2650	820	1000	200	70	50	5600	Box xx/...	
2000	Extra-EU design	5000	21275	8	0.8	98.70	98.88	1.38	4.64	63	78	2150	1250	2600	1070	1200	200	70	50	5400	Box xx/...	
	Ecodesign phase 2	2691	17600	8	0.8	99.00	99.17	1.20	4.49	55	70	2250	1250	2700	1070	1200	200	70	50	6800	Box xx/...	
2500	Extra-EU design	5800	25300	8	0.7	98.77	98.94	1.33	4.59	65	80	2200	1250	2700	1070	1200	200	70	50	6300	Box xx/...	
	Ecodesign phase 2	3208	20900	8	0.7	99.04	99.21	1.15	4.45	56	71	2450	1300	2800	1070	1200	200	70	50	8200	Box xx/...	
3150	Extra-EU design	6800	27600	8	0.6	98.92	99.06	1.19	4.48	66	81	2450	1250	2700	1070	1200	200	70	50	7650	Box xx/...	
	Ecodesign phase 2	3933	24200	8	0.6	99.11	99.26	1.09	4.40	58	74	2700	1350	2900	1070	1200	200	70	50	10500	Box xx/...	

Different Designs (i.e. Ambient / room Temperature, B or H insulation class and different conductive material, etc.) are available on demand

Our company reserves the right to modify technical details without prior notice

Enclosure xx -> Please ask Tesar

# A World of Reliability

## Over 100,000 installed transformers

Tesar has been synonymous with innovation and first-rate quality since 1979

It can boast over 100,000 units installed all over the world: this is Tesar's calling card. Tesar has been operating in the market with its own designs since 1979. Quality, Research and Development have granted continuous product improvement in this time. In 1983 Tesar was the first company to study and test fire behaviour of transformers.

In 2004 Tesar was one of the few manufacturers worldwide to achieve the E2 C2 F1 (Environmental, Climatic and Fire behaviour tests) Certificate and in 2013 it achieved the certification for the E3 condition for the installation of transformers within Wind Power Plants.

Again, in 2014, before the norms would provide it, Tesar successfully tested the functioning of transformers after a F1 fire behaviour test. At the end of 2014 Tesar was once again ahead of its time and succeeded in a test anticipating the provisions of the norm as amended in 2018 and the test went far beyond the values of the time (class C2), Tesar Transformers also passed a test for storage and transport up to -50 °C.

In 2021 Tesar was among the first companies to achieve a Certification for the E4 C3 F1 classes in compliance with the new IEC 60076-11:2018-10 standard.



# Special Applications

Tesar also manufactures transformers for special applications

Multi-pulse Transformers for any kind of application.

Transformers for BESS (Battery Energy Storage System) applications.

Cast resin power transformers up to 20MVA – 72.5kV.

Single-phase Transformers.



# Metal Enclosures

## For maximum protection

### Metal Enclosures

They can provide protection against solid and liquid items/objects and they prevent the staff from coming into direct contact with live parts. They are completely planned and manufactured on a custom-design basis for any kind of installation with a degree of protection up to IP54.

They are available in two different types, that is either integrated into the transformer (built-in) or as a free-standing item to be set onto the floor.

### General Features

- Sendzimir steel sheet metal
- RAL 7035 Colour (other colours are available on demand)
- Openings for HV/LV cable/wire entry from above and from below

- Either built-in on board the transformer or, as free-standing items

### Optional Accessories

- HV/LV electrical cable boxes with or with gland plates
- Auxiliaries electrical connection boxes
- AREL lock
- Cable/wire hook-up device
- Opening for bus-bar/bus duct connections
- Fans and/or heat exchangers
- It is possible to ask for painting/coating classes up to C5H in compliance with the IEC12944-6 standard



Degree of Protection	Solid Items	Liquids	Installation
IP31	Protection against solid items $\leq 2.5\text{mm}$	Protection against vertically falling water drops	Indoor
IP23	Protection against solid items $\leq 12\text{mm}$	Protection against direct water splashes up to $60^\circ$ from the vertical	Indoor / Outdoor

Tesar can manufacture enclosures up to IP54 degree of protection on demand

## Overall Dimensions

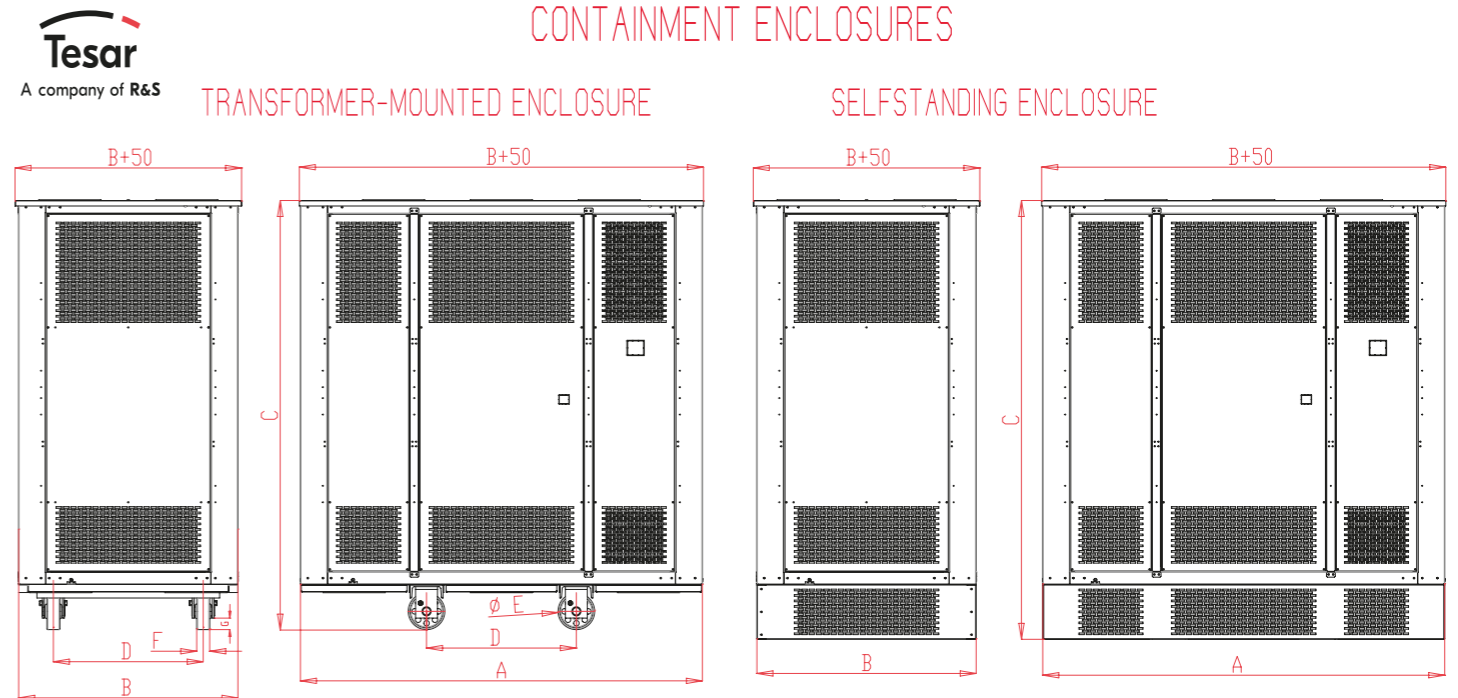

Built-in								
Type	A	B	C	D	E	F	G	Weight
	mm	mm	mm	mm	mm	mm	mm	kg
Box 1/s	1800	1200	1760	520	125	40	35	250
Box 1z/s	1800	1200	2010	520	125	40	35	250
Box 2/s	2200	1200	2260	670	125	40	35	280
Box 2z/s	2200	1200	2510	670	125	40	35	280
Box 3/s	2500	1350	2410	820	125	40	35	380
Box 3z/s	2500	1350	2660	820	125	40	35	380
Box 4/s	2700	1550	2600	1070	200	70	50	450
Box 4z/s	2700	1500	2850	1070	200	70	50	450

Free-standing								
Type	A	B	C	D	E	F	G	Weight
	mm	mm	mm	mm	mm	mm	mm	kg
Box 1/a	1800	1200	1600	520	125	40	35	250
Box 1z/a	1800	1200	1850	520	125	40	35	250
Box 2/a	2200	1200	2100	670	125	40	35	280
Box 2z/a	2200	1200	2350	670	125	40	35	280
Box 3/a	2500	1350	2250	820	125	40	35	380
Box 3z/a	2500	1350	2500	820	125	40	35	380
Box 4/a	2700	1550	2350	1070	200	70	50	450
Box 4z/a	2700	1500	2850	1070	200	70	50	450

We reserve the right to change technical details without prior notice

# Our Accessories

Different types of environments and different applications have different needs. This is why Tesar offers a wide range of accessories, so as to always be able to provide the perfect solution for our customers



### TSX1 Temperature control device

Electronic device to control the temperature of cast resin transformers.

- N.4 analogue input channels for the monitoring of the temperature of windings and of the magnetic core.
  - N. 4 output relays (Fans, Alarm, Release and Generic Alarm).
- The temperature is monitored by means of PT100  $\Omega$  probes/sensors. The TSX1 temperature thresholds are completely adjustable. The TSX1 device is also available in the configuration with RS485 serial output with RTU MODBUS (TSX1s) protocol or Ethernet.



### TSX3 Temperature control device

Electronic device to control the temperature of cast resin transformers.

- N. 4 analogue input channels for the monitoring of the temperature of windings and of the magnetic core.
  - N. 4 output relays (Fans, Alarm, Release and Generic Alarm).
- Temperature is monitored by means of PTC probes/sensors.



### TSX6c fans protection device

Electronic device for the protection and control of the ventilation system.

- N. 2 digital inputs to enable the ventilation system.
  - N. 2 output signals to signal malfunctions of the fans.
  - N. 6 power supply units with magneto-thermic relay.
- By means of TSX6c device, fans are constantly monitored and protected.



### PT 100 $\Omega$ and PTC sensors/probes

They provide a real-time monitoring process of temperatures. A PT 100  $\Omega$  sensor is installed on each BT winding. An additional PT 100  $\Omega$  sensor can be installed so as to monitor the temperature of the magnetic core. The temperature probes are connected with an auxiliary box installed onto the metal frame of the transformer. As an alternative two PTC sensors are installed onto each LV winding, so as to signal in case special alarm and release thresholds are reached. Temperature sensors are connected to an auxiliary box installed onto the metal frame of the transformer.

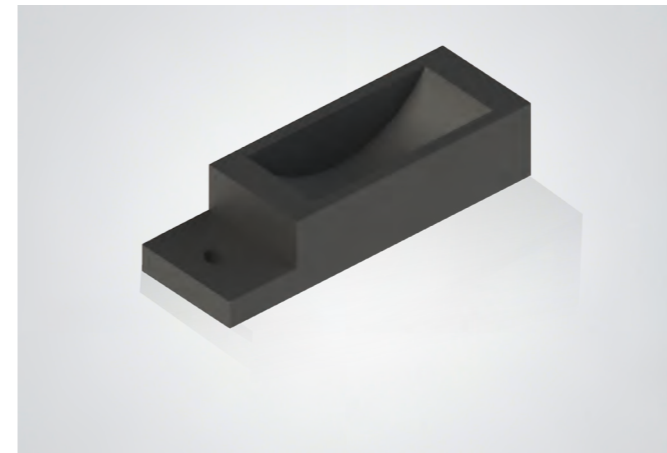

### Antivibration bearings/support devices

Antivibration support devices are an intelligent and compact solution, which reduces vibrations as well as the noise level of transformers. They avoid the transfer of the transformer vibrations to the surrounding environment.



### Ventilation Bars

The forced air cooling system reduces the operational temperature of the transformer and it allows a temporary and continuous increase of the transformer power. The ventilation system, made up of two ventilation bars, each of which featuring three engines, can increase the nominal power of the transformer up to 140%.

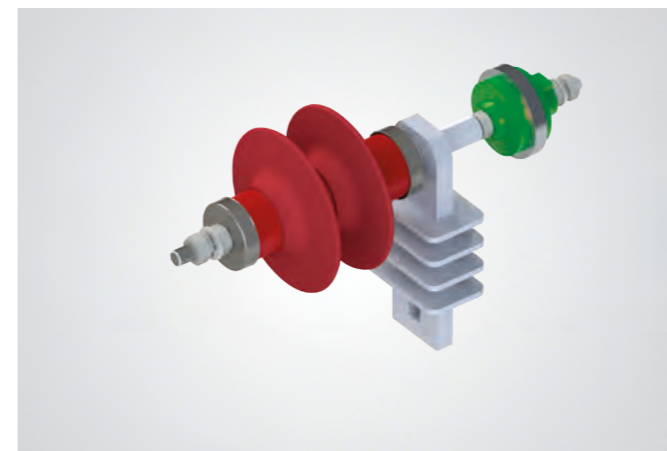

### HV overvoltage arresters

They represent the primary protection against lightning or operating overvoltage/surge. A comfortable and reliable solution to extend the lifecycle of the transformer. They are highly recommended for installations where high presence of lightning is foreseen.

# Description and Features

## Description and Features

1. Auxiliaries connection box
2. PT 100 or PTC Sensors in LV windings
3. HV Terminals
4. HV adjustment terminal board
5. Magnetic core frame

6. LV Terminals
7. Lifting eye-bolts
8. HV windings
9. Magnetic core
10. LV Windings
11. Trolley with bidirectional wheels

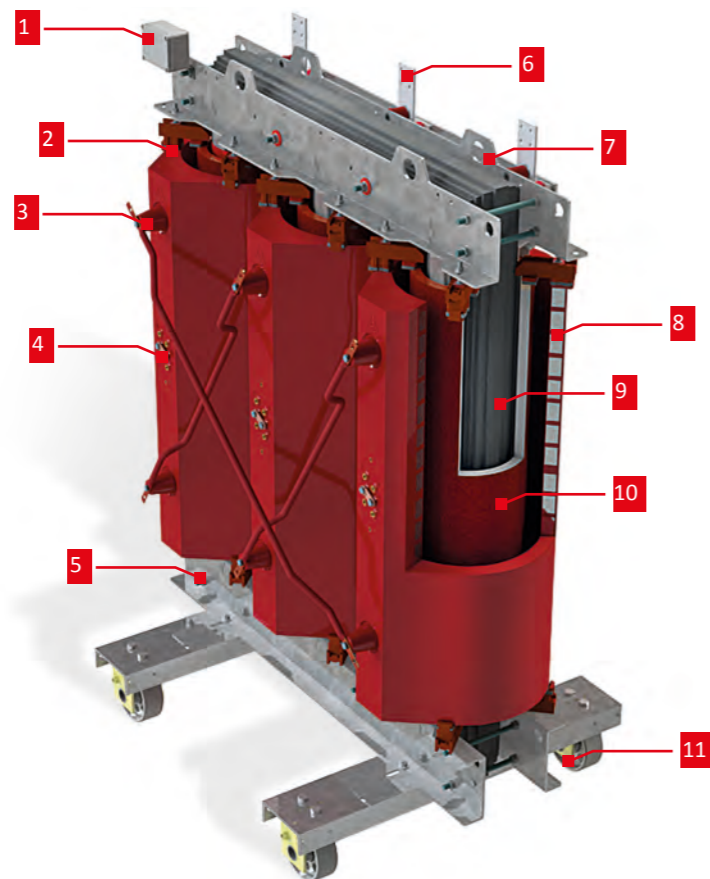

# The main Features

## Low operational expenses/overheads

Low losses within the magnetic core and the windings reduce operational expenses.

## Frames

Hot-dip galvanised frames guarantee the best performances within a polluted environment.

## High Reliability

The high-tech production process of the windings conveys a high level of reliability to our products.

## Maximum Safety

Resin and insulating materials used in planning and manu-

facturing processes of Tesar transformers guarantee a high level of self-extinguishing features, as well as low emissions of toxic gases.

## No Maintenance Required

Tesar cast resin transformers are designed so as to endure and resist against the worst climate and environmental conditions. Preventive maintenance consists of a simple visual check.

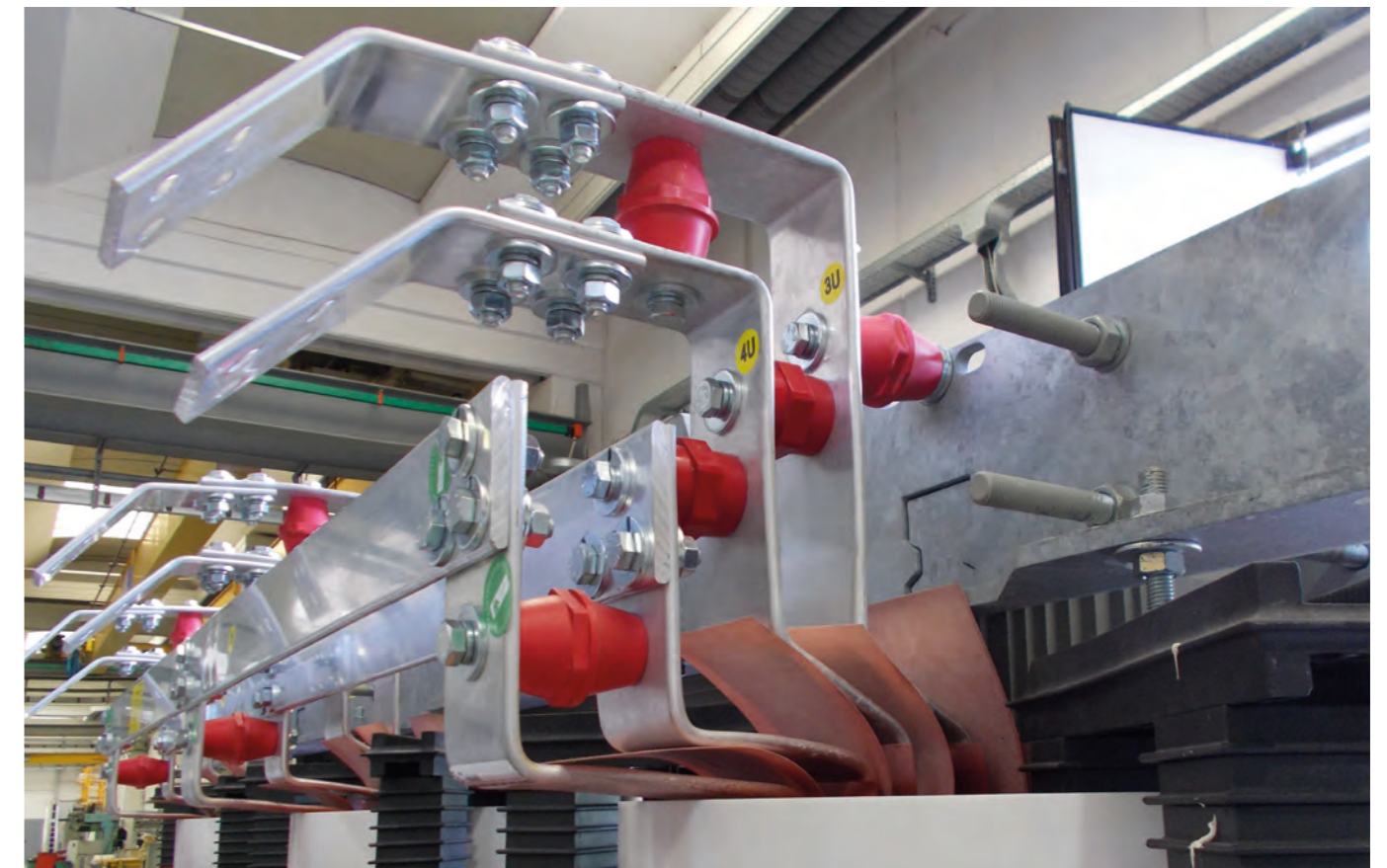

# Certified Quality

## Quality in production, control and results

Tesar is proud to boast a Laboratory which has been fully approved by CESI (International Ethics and Scientific Commission) offering an impressive portfolio of routine tests, type and special tests performed in compliance with IEC norms or, varied special tests agreed in advance with our Customers.

Tesar tools/instruments are constantly kept under a calibration system. The corresponding calibration certificates are available on demand. Tesar management, quality, environmental and safety systems are certified in compliance with ISO 9001, ISO 14001 and ISO 45001 standards.



# Environmental, Climate and Fire-resistance Classes

## E - C - F classes

Tesar cast resin transformers are suitable for any climate conditions

Tesar Italy successfully achieved the Test Certificate for the Environmental, Climatic and Fire behaviour E4-C3-F1 classes as per IEC 60076-11:2018 on a cast resin transformer with rated power 1000kVA and rated voltages 20/0.4kV BIL 125kV in respect of the last ECO DESIGN Tier2 directive as regards losses, as well as per EU 548/2014 and EU 1783/2019 directives.

Here is the list of the tests carried out in sequence on the same transformer:

- C3 Thermal shock test
- E4 Condensation and Humidity penetration test
- F1 Fire-behaviour test and checking of gases emission were managed and certified by the CESI independent third-party laboratory based in Milan.

Tesar went far beyond the requirements of the C3 class and tested its transformer at -50°C, proving that it is suitable for extreme climate conditions.

### Key Features and Benefits:

The achievement of compliance with requirements for the certification means that Tesar transformers are suitable to work in environments close to the sea, desert areas or, heavily polluted areas and in ones subject to extremely cold temperatures.

Thanks to this latest innovation, Tesar Italy took a major step forward towards preserving our environment and meeting our customers most demanding requests, driven in demand by the increase in special installations and projects around the world.



## Transformers suitable for types of environment subject to seismic hazards

Tesar transformers grant earthquake-resistance and are equipped with pre-set holes for ground mounting, so as to avoid the possibility of overturning/tilting risks. The seismic test calculation report can be furthermore supplied on demand.

## Innovative, efficient and confidential

### Electromagnetic Analysis

The levels of electromagnetic emissions of an electric device are to be kept under control in order to respect the threshold provided for by law and most of all in order to respect the health of people working or, living in the surrounding areas or, near to the place of installation of the device itself.

Not only do Tesar transformers comply with the limit of  $10 \mu\text{T}$  established by the DPCM (Prime Ministerial Decree) regulation dated the 8<sup>th</sup> July 2003, but they also make it possible to further reduce the magnetic field by means of being equipped with a metal enclosure.

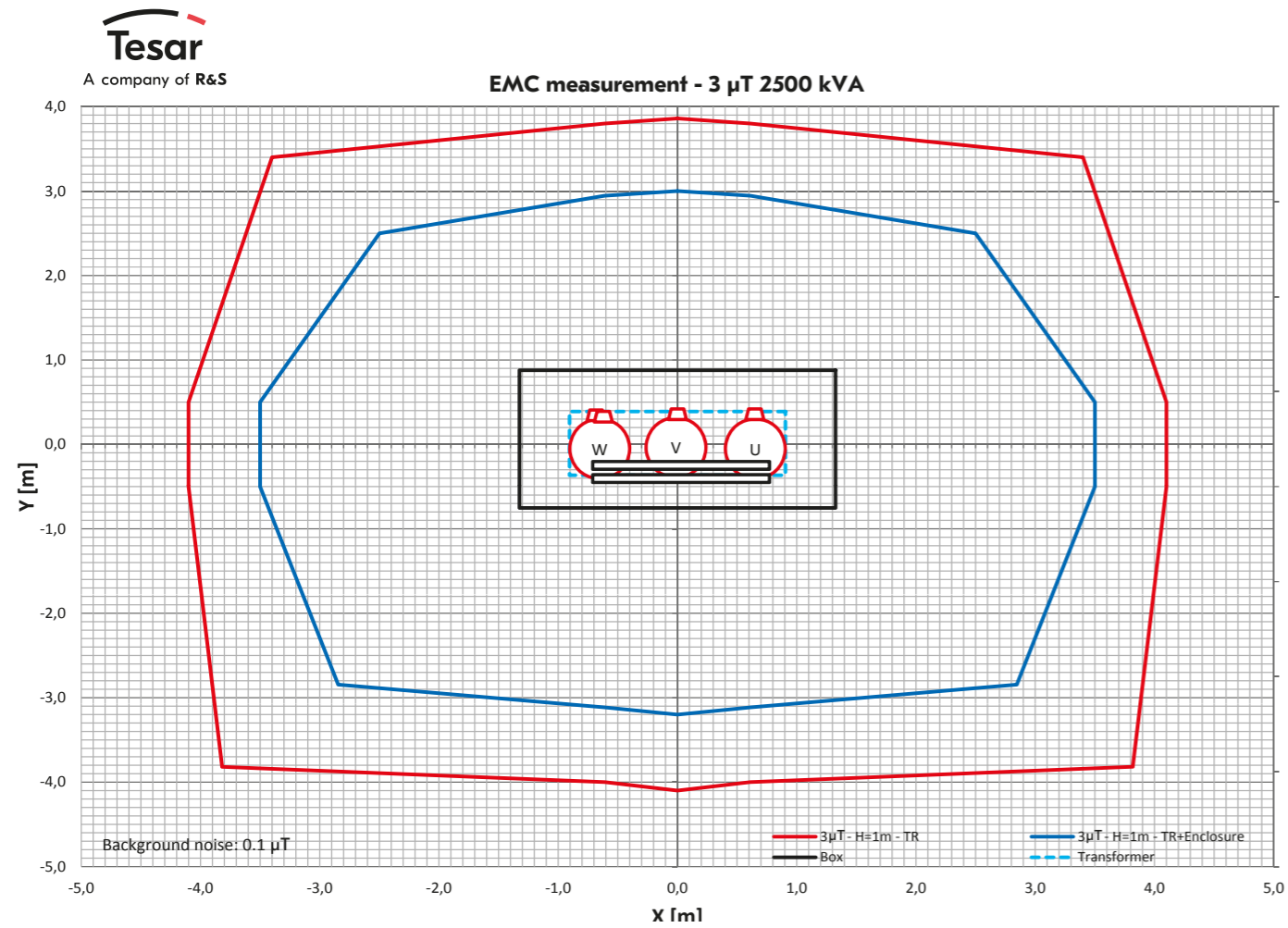



# Customer-care and after-sales Service Activities

## An Expert Team at our Customers' service

### Spare parts

Tesar grants the possibility to supply all spare parts our customers may need during the transformer working life.

### Start-up Customer Service

Tesar grants the support of a team of technical experts so as to supply customer care service during the transformer start-up phases.

### Assembly

A team of specialized technical experts is at your disposal to perform the assembly of Tesar transformers (cables/wires connections not included).

### On-site Tests

Tesar can provide technical experts and equipment to perform on-site routine tests.

### Routine/ordinary and extraordinary Maintenance Procedures

Tesar can perform either routine or extraordinary maintenance procedures by means of remote systems making use

of augmented reality technology.

### Repair procedures

Thanks to over 40 years' experience in the field, Tesar can repair any kind of transformer after a failure or breakdown.

### Regeneration/ Reconditioning of old transformers

Tesar can boast a team of specialized technical experts who are able to assess the conditions of your transformer and decide on the best solution together with you: that is either to replace your transformer or, to regenerate and recondition it by means of revamping procedures.

### 24h Customer-Care Support Service

Tesar can offer you a 24-hour Customer Care Support Service with the possibility to also perform interventions by means of a remote control system, making use of the most modern augmented-reality technologies.

### Equipment Rental

Tesar can support its customers by offering a wide range of transformers available for short-term or long-term rental.





# Sustainability

## Circular Economy



Tesar transformers are environmentally friendly and sustainable during their whole life-cycle, since at the end of their useful life they can be recycled for more than 90%. In details:

• Core



95% Iron (recyclable)

• HV Winding



50% Aluminium or Copper (recyclable)

• LV Winding



85% Aluminium or Copper (recyclable)

• Container



95% Iron (recyclable)



# Test Room

Tesar test rooms within the plants of Chiaveretto and Castelnuovo are equipped with the necessary devices to carry out the required tests so as to comply with legislation in force (i.e. IEC 60076, IEC 50329, IEC 60146) and in particular:

## Routine Tests

- Visual dimensional control
- Insulation test on voltage applied to the HV winding
- Insulation test on voltage applied to the LV winding
- Induced voltage insulation/withstand test
- Measurement of the transformation ratio and vector group control
- Measurement of winding resistances
- Measurement of short-circuit impedance
- Measurement of load losses
- Measurement of losses and of no-load current
- Partial discharges measurement

## Other Tests

- Lightning impulse resistance test
- Heating test
- Noise level measurement
- Heating test with overload cycles
- SFRA, Sweep frequency response analysis
- Measurement of homopolar impedance
- Estimate of no-load current harmonic content
- Metering with recurring pulses
- Zero-sequence impedance measurement
- Measurement of capacity and Tan  $\delta$
- Measurement of electromagnetic fields

Our test rooms are furthermore equipped with advanced digital tools making it possible for our customers to follow tests live on site or through video conference.

Tesar technical experts in charge of test rooms are in constant and direct contact with the most important international qualified laboratories, for product certification, qualification and homologation.

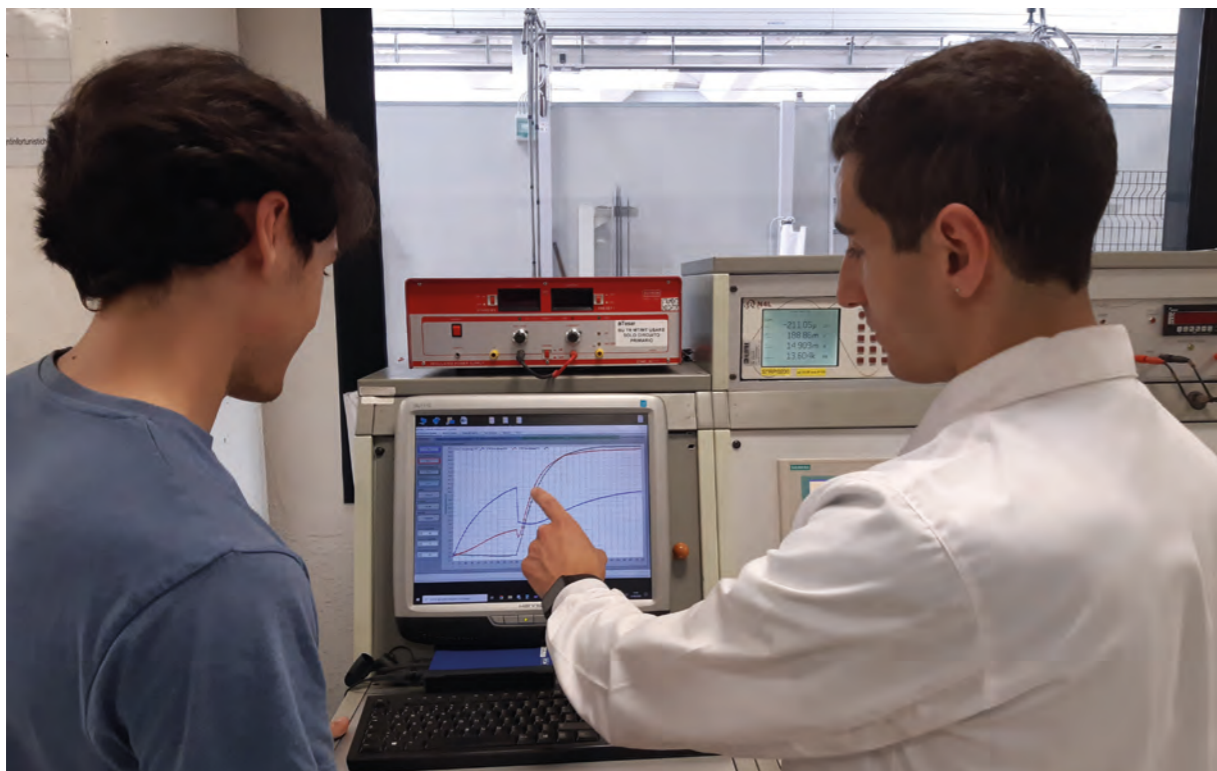

## Switzerland

R&S International Holding AG  
Reuslistrasse 32  
4450 Sissach  
+41 61 976 34 66  
info@the-rsgroup.com

## Czech Republic

SERW spol. s.r.o.  
Tymákovská 42 Sedlec  
332 02 Starý Plzenec  
+420 377 965 057  
serw@serw.cz

## UAE

Tesar FZE  
Dubai Airport Free Zone  
Office 118, Building 5E, Block A  
+971 4 2045305/06  
tesarfze@tesar.eu

## Switzerland

Rauscher & Stoecklin AG  
Reuslistrasse 32  
4450 Sissach  
+41 61 976 34 66  
info@raustoc.ch

## Poland

ZREW Transformatory S.A.  
ul. Rokicińska 144  
92-412 Łódź  
+48 42 671 86 00  
transformatory@zrew-tr.pl

## UAE

Tesar Gulf  
P.O. Box #13898  
Al Ain  
+971 3 7847900  
tesarfze@tesar.eu

## Italy

Tesar S.r.l.  
Loc. Chiaveretto 37/B  
52010 Subbiano Arezzo  
+39 0575 3171  
info@tesar.eu

## Poland

Tesar Polska Sp. z o.o.  
ul. Skarbowa 34  
32-005 Niepołomice  
+48 12 312 90 41  
info@tesarpolska.pl

## Argentina

Tadeo Czerweny Tesar S.A.  
Av. República 328 (S2252BQQ)  
Gálvez, Santa Fe  
+54 3404 48 7200  
info@tesar.eu

